







TruVision 6MP and 12MP 360° Camera Installation Manual

Copyright	© 2019 United Technologies Corporation, Interlogix is part of UTC Climate, Controls & Security, a unit of United Technologies Corporation. All rights reserved.
Trademarks and patents	Trade names used in this document may be trademarks or registered trademarks of the manufacturers or vendors of the respective products.
Disclaimer	Information in this document is subject to change without notice. No part of this document may be reproduced or transmitted in any form or by any means, electronic or mechanical, for any purpose, without the express written permission of UTC Fire & Security Americas Corporation, Inc.
Manufacturer	Interlogix. 2955 Red Hill Avenue, Costa Mesa, CA 92626-5923, USA Authorized EU manufacturing representative: UTC Fire & Security B.V. Kelvinstraat 7, 6003 DH Weert, The Netherlands
Certification	   
FCC compliance	Class A: This equipment has been tested and found to comply with the limits for a Class A digital device, pursuant to part 15 of the FCC Rules. These limits are designed to provide reasonable protection against harmful interference when the equipment is operated in a commercial environment. This equipment generates, uses, and can radiate radio frequency energy and, if not installed and used in accordance with the instruction manual, may cause harmful interference to radio communications. Operation of this equipment in a residential area is likely to cause harmful interference in which case the user will be required to correct the interference at his own expense.
FCC conditions	This device complies with Part 15 of the FCC Rules. Operation is subject to the following two conditions: (1) This device may not cause harmful interference. (2) This Device must accept any interference received, including interference that may cause undesired operation.
ACMA compliance	Notice! This is a Class A product. In a domestic environment this product may cause radio interference in which case the user may be required to take adequate measures.
Canada	This Class A digital apparatus complies with Canadian ICES-003. Cet appareil numérique de la classe A est conforme à la norme NMB-0330 du Canada.
cUL	Safety Instruction: Improper use or replacement of the battery may result in explosion hazard. Replace with the same or equivalent type only. Dispose of used batteries in conformance with the local codes. Instructions de sécurité : L'utilisation ou le remplacement inadéquats de la pile peuvent entraîner un risque d'explosion. Remplacez-la par le même type ou l'équivalent du même type seulement. Jetez les piles usagées conformément aux directives fournies par le fabricant de la pile.
European Union directives	This product and - if applicable - the supplied accessories too are marked with "CE" and comply therefore with the applicable harmonized European standards listed under the EMC Directive 2014/30/EU, the RoHS Directive 2011/65/EU.



Product warnings and disclaimers

2012/19/EU (WEEE directive): Products marked with this symbol cannot be disposed of as unsorted municipal waste in the European Union. For proper recycling, return this product to your local supplier upon the purchase of equivalent new equipment, or dispose of it at designated collection points. For more information see: www.recyclethis.info.

2013/56/EU & 2006/66/EC (battery directive): This product contains a battery that cannot be disposed of as unsorted municipal waste in the European Union. See the product documentation for specific battery information. The battery is marked with this symbol, which may include lettering to indicate cadmium (Cd), lead (Pb), or mercury (Hg). For proper recycling, return the battery to your supplier or to a designated collection point. For more information see: www.recyclethis.info.

THESE PRODUCTS ARE INTENDED FOR SALE TO AND INSTALLATION BY QUALIFIED PROFESSIONALS. UTC FIRE & SECURITY CANNOT PROVIDE ANY ASSURANCE THAT ANY PERSON OR ENTITY BUYING ITS PRODUCTS, INCLUDING ANY "AUTHORIZED DEALER" OR "AUTHORIZED RESELLER", IS PROPERLY TRAINED OR EXPERIENCED TO CORRECTLY INSTALL FIRE AND SECURITY RELATED PRODUCTS.

For more information on warranty disclaimers and product safety information, please check www.firesecurityproducts.com/policy/product-warning/ or scan the following code:



Contact information and manuals/ tools/ firmware

For contact information and to download the latest manuals, tools, and firmware, go to the web site of your region:

Americas: www.interlogix.com

EMEA: www.firesecurityproducts.com

Manuals are available in several languages.

Australia/New Zealand: www.utcfs.com.au

Content

Introduction 2

Product overview 2

Installation 2

Installation environment 2

Contact information and manuals/tools/firmware 3

Package contents 3

Cable requirements 5

Camera description 5

Install the camera 6

IR illuminators 9

Accessing the SD card 9

Mounting accessories 10

Using the camera with an Interlogix NVR or another system 11

Using the camera with TruVision Navigator 11

Specifications 13

Pin definitions 14

Introduction

Product overview

This is the installation manual for TruVision 6MP and 12MP 360° camera models:

SKU	Description
TVF-5201	TruVision 360° IP Dome, 6MP, Indoor, DWDR, 1.29 mm fisheye lens, True D/N, 15m IR, Bi-directional audio (built-in mic & speaker), Alarm (alarm input and alarm output), SD/SDHC slot, PoE + (802.3-at) /12 VDC, Gray
TVF-5202	TruVision 360° IP Dome, 12MP, indoor, DWDR, 1.29 mm fisheye lens, True D/N, 15m IR, bidirectional audio (built-in mic & speaker), Alarm (alarm input and alarm output), SD/SDHC slot, PoE + (802.3-at) /12 VDC, Gray
TVF-5203	TruVision 360° IP Dome, 6MP, Outdoor, DWDR, 1.29 mm fisheye lens, True D/N, 15m IR, bidirectional audio (built-in mic & speaker), Alarm (alarm input and alarm output), SD/SDHC slot, IP67, IK10, PoE + (802.3-at) /12 VDC, Gray
TVF-5204	TruVision 360° IP Dome, 12MP, Outdoor, DWDR, 1.29 mm fisheye lens, True D/N, 15m IR, bidirectional audio (built-in mic & speaker), Alarm (alarm input and alarm output), SD/SDHC slot, IP67, IK10, PoE + (802.3-at) /12 VDC, Gray

Installation

This chapter provides information on how to install the cameras.

Warning: When the 360° camera is operating, the surface of the housing will be hot to the touch. The heat buildup is due to the processing power that is required to operate the camera.

Installation environment

When installing your product, consider these factors:

- **Electrical:** Install electrical wiring carefully. It should be done by qualified service personnel. Always use a proper PoE switch or a 12 VDC UL listed Class 2 or CE certified power supply to power the camera. Do not overload the power cord or adapter.

- **Ventilation:** Ensure that the location planned for the installation of the camera is well ventilated.
- **Temperature:** Do not operate the camera beyond the specified temperature, humidity or power source ratings. The operating temperature of the indoor camera is between -40 °C to +60 °C (40 °F to +140 °F). The operating temperature of the outdoor camera is between -40 °C to +60 °C (40 °F to +140 °F). Humidity 95% or less (non-condensing) for both cameras.
- **Moisture:** Do not expose the camera to rain or moisture, or try not to operate it in wet areas. Turn the power off immediately if the camera is wet and ask a qualified service person for servicing. Moisture can damage the camera and also create the danger of electric shock.
- **Servicing:** Do not attempt to service this camera yourself. Please refer to the instructions in this manual when removing the camera cover. Refer all servicing to qualified service personnel.
- **Cleaning:** Do not touch the bubble with fingers. If cleaning is necessary, use a clean cloth with some ethanol and wipe the camera bubble gently.

Contact information and manuals/tools/firmware

For contact information and to download the latest manuals, tools, and firmware, go to the web site of your region:

Americas:	www.interlogix.com
EMEA:	www.firesecurityproducts.com Manuals are available in several languages.
Australia/New Zealand:	www.utcfs.com.au

Package contents

Check the package and contents for visible damage. If any components are damaged or missing, do not attempt to use the unit; contact the supplier immediately. If the unit is returned, it must be shipped back in its original packaging.

Indoor camera

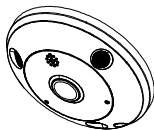

Outdoor camera



Screws:

Drywall anchor
7.5 x 24.5mm (4 pcs)



Screw M4
7 x 25mm (4 pcs)



Drill template

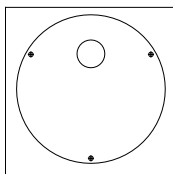

Protective tape
(Only for outdoor cameras)

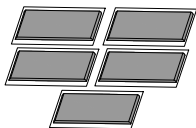

Installation manual

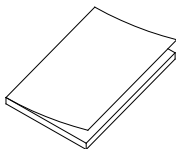

Battery Disposal sheet

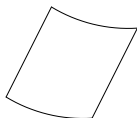

Hex wrench 95 x 50mm

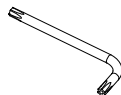

12 VDC connector

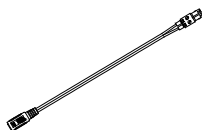

Protective water resistant RJ45
connector cover: Provides water
resistance to network cable
connector

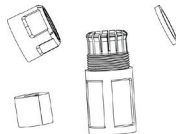

Equipment disposal sheet

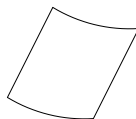

CAUTION: Use direct plug-in UL listed power supplies marked Class 2/CE certified or LPS (limited power source) of the required output rating as listed on the unit.

Cable requirements

For proper operation, adhere to the following cable and power requirements for the cameras. Category 5 cabling or better is recommended. All network cabling must be installed according to applicable codes and regulations.

The recommended power cable requirements to use are a 12 VDC power jack or PoE (802.3at) when connecting the camera.

For outdoor applications - after routing and connecting the cables, use the protective tape to wrap the connectors. This will provide an added layer of protection from the elements.

Camera description

Figure 1: 360° camera

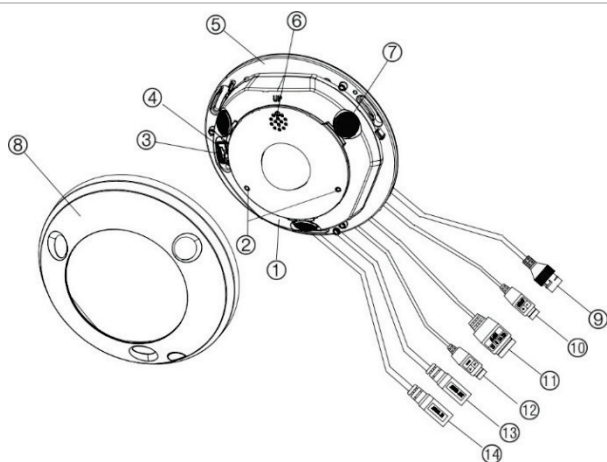

- | | |
|--------------------------|---|
| 1. Cover | 8. Camera cover ring |
| 2. MIC | 9. PoE+ & network port |
| 3. Micro SD card slot | 10. 12 VDC |
| 4. Reset button | 11. Alarm input (pins IN and G, Alarm output (pins 1A and 1B) |
| 5. Base | 12. RS-485 port |
| 6. Speaker | 13. Audio out |
| 7. Three IR illuminators | |

Install the camera

Note: If the light source where the camera is installed experiences rapid, wide-variations in lighting, the camera may not operate as intended.

To install the 360° camera on a ceiling or wall:

1. Prepare the mounting surface.

Use the drill template provided to draw the positions of the screws and cabling hole.

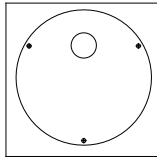

2. Install the three screws and drywall anchor in the ceiling or wall, leaving clearance to slide the camera in to place. See below.

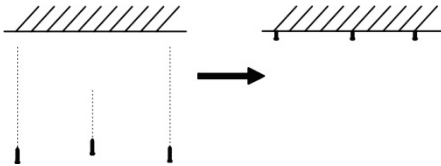

Important: When mounting the camera to a wall, ensure that the 'UP' reference on the camera base is pointing upwards.

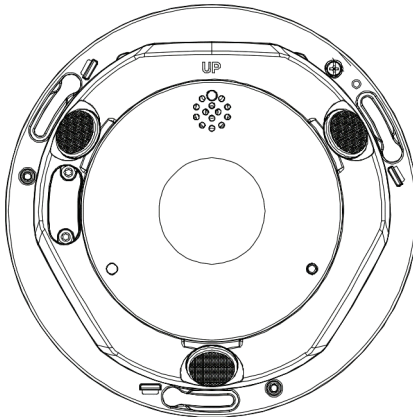

3. Remove the camera cover ring from the camera.

Using the hex wrench provided, unscrew the hex head screw located under the small flap on the cover.

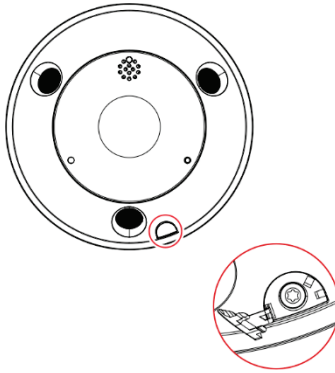

Using a flathead screwdriver, release the two clips on the base of the camera to release the cover.

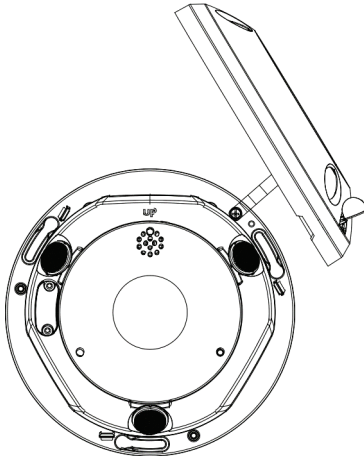

Grasp the opening on the side of the cover, and pull the cover and base apart to open the camera.

Note: For further information on removing the cover ring from the camera, please refer to the guide, "Instructions to remove the 360° camera cover".

4. Connect the cables to the camera.

5. Attach the camera to the ceiling/wall.

Align the holes on the base of the camera with the three screws in the ceiling/wall and rotate the camera to lock it into position.

When mounting the camera to a wall, ensure that the 'TOP' reference is pointing up.

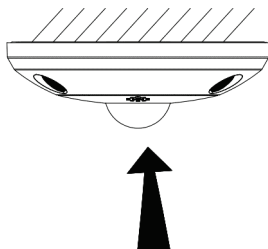

6. Tighten the three screws to securely fix the camera to the ceiling/wall.
7. When re-attaching the camera cover ring, ensure that the groove/opening near the cover screw is not up against a wall or ceiling. You will need to have access to that area when removing the camera cover.

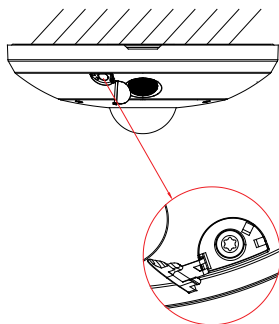

8. Tighten the cover screw in the camera cover ring to securely reattach the cover to the camera. Back boxes are not included with the 360° cameras. They are available separately.

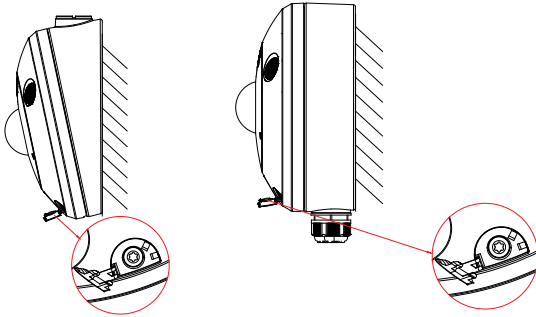

IR illuminators

The camera's built-in IR illumination provides high-quality video in low-light environments, even when there is no other illumination available.

You can configure the IR illumination using a web browser or a client software. If the function is enabled, the IR light is on when the camera enters night (black and white) mode. If disabled, the IR light is always off.

The visible IR range may vary due to multiple factors, such as weather, IR reflection rate of viewing objects, lens adjustment, and camera settings. Please refer to the camera datasheet for the standard IR range.

Note: Avoid installing the IR camera closely facing a tree or wall. The reflection will cause over-exposure and lose visibility of detail in field of view.

Accessing the SD card

Remove the camera cover ring and insert an SD card up to 256GB for local storage as a backup in case the network fails. An SD card is NOT supplied with the camera.

Figure 2: Access the micro SD card in the camera

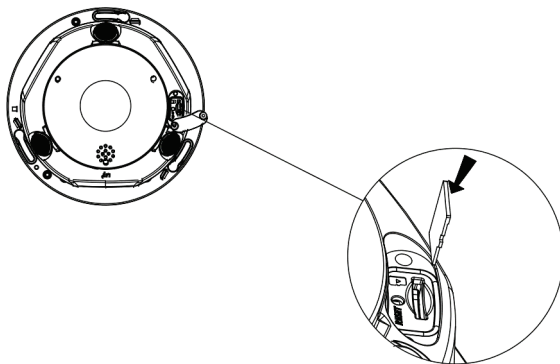

Video and log files stored on the micro SD card can only be accessed via the web browser. You can access video from the card using TruVision Navigator or a recording device, but log files must be accessed via the web browser interface.

Mounting accessories

Brackets and back boxes described below are available for other installation scenarios. However, these brackets and accessories are NOT supplied with the camera. Please check the corresponding datasheet and contact the supplier for orders.

Note: The mounting brackets are shipped with installation hardware.

TruVision 360° camera round back box (TVF-BBM)

The 360° camera can be installed on a TVF-BBM round back box attached to a surface, such as a wall or ceiling, or to an electrical double gang box.



Round back box

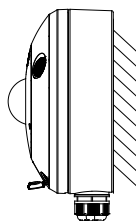

Example: Round back box with camera

TruVision 360° camera round angled back box (TVF-WBM)

The 360° camera can be installed on TVF-WBM round angled back box for angled viewing on wall or ceiling or attach to an electrical double gang box.



Round angled back box

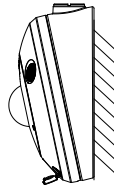

Example: Round angled back box with camera

TruVision 360° camera cup base (TVF-CBM)

The 360° camera can be installed on a cup base then attached to a TruVision swan neck bracket (TVD-SNB) for wall mounting, or to a TruVision pendant (TVD-PPB) for ceiling mounting.

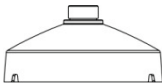

Cup base

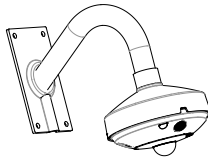

Example: Cup base with wall mount

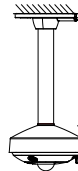

Example: Cup base with pendant mount

For further information, please refer to the “TruVision 360° Camera Bracket Installation Manual”.

Using the camera with an Interlogix NVR or another system

Please refer to the NVR/DVR user manuals for instructions on connecting and operating the camera with these systems.

Using the camera with TruVision Navigator

A camera must be connected to an Interlogix NVR in order to be operated by TruVision Navigator.

Please refer to the TruVision Navigator user manual for instructions on operating the camera with the TruVision Navigator.

Instructions to remove the TruVision 360° camera cover

To remove the TruVision 360° camera cover:

1. Open the small flap on the camera cover. Using the hex wrench provided, loosen the small screw.

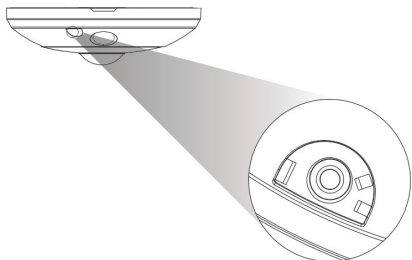

2. Two clips on the cover ring lock it on to the camera base.

Using a flathead screwdriver, release the two clips on the base of the camera to detach the cover.

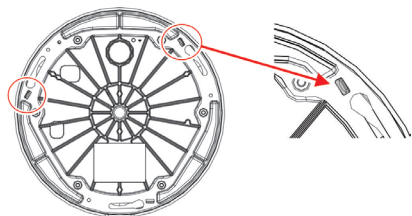

3. Grasp the opening on the side of the cover (1), and pull the cover and base apart to open the camera.

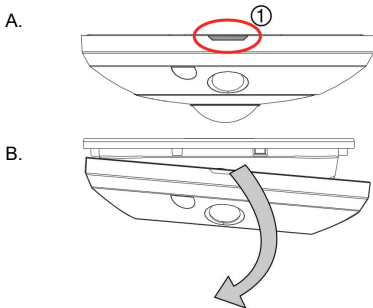

C.

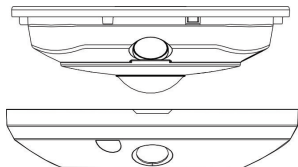

Note: When the TruVision 360° camera is mounted to the wall or ceiling, you will not have access to the two clips. In such situations, use a flathead screwdriver to gently pry the cover (see step 3 A.1) apart from the camera base.

Specifications

Electrical

Voltage input 12 VDC \pm 10%, PoE + (802.3-at)

Power consumption Max. 15 W

Miscellaneous

Connectors DC jack flying lead, RJ45 flying lead

Operating temperature Indoor camera: -40°C to +60°C (40°F to +140°F).
Humidity 95% or less (non-condensing)
Outdoor camera: -40°C to +60°C (40°F to +140°F).
Humidity 95% or less (non-condensing)

Dimensions Indoor camera: 167.4 × 47 mm (6.59" × 1.85")
Outdoor camera: 167.4 × 55 mm (6.59" × 2.17")

Weight Indoor camera: 710 g (1.57 lb.)
Outdoor camera: 750 g (1.65 lb.)

Environmental rating IP67 and IK10 (only for the outdoor version)

Indoor camera dimensions:

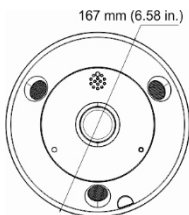

Outdoor camera dimensions:

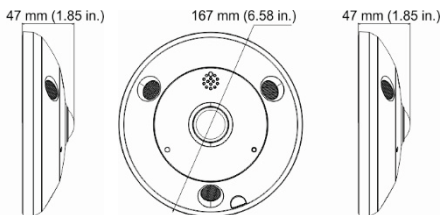

Pin definitions

There are eight wires on a standard UTP/STP cable and each wire is color-coded. The following shows the pin allocation and color of straight and crossover cable connection:

Figure 3: Straight-through cable

















1	White/Orange		White/Orange	1
2	Orange		Orange	2
3	White-Green		White-Green	3
4	Blue		Blue	4
5	White/Blue		White/Blue	5
6	Green		Green	6
7	White/Brown		White/Brown	7
8	Brown		Brown	8

Figure 4: Cross-over cable

1	White/Orange		White/Orange	1
2	Orange		Orange	2
3	White-Green		White-Green	3
4	Blue		Blue	4
5	White/Blue		White/Blue	5
6	Green		Green	6
7	White/Brown		White/Brown	7
8	Brown		Brown	8

Please make sure your connected cables have the same pin assignment and color as above before deploying the cables in your network.

